

GSM/EDGE Optimized, High Linearity Direct Quadrature Modulator

FEATURES

- Optimized Image Rejection for 850MHz to 965MHz
- High OIP3: +22.9dBm at 900MHz
- Low Output Noise Floor at 5MHz Offset:
 - No RF: -159.4dBm/Hz
 - P_{OUT} = 4dBm: -153dBm/Hz
- Integrated LO Buffer and LO Quadrature Phase Generator
- 50Ω AC-Coupled Single-Ended LO and RF Ports
- 50Ω DC Interface to Baseband Inputs
- Low Carrier Leakage: -43dBm at 900MHz
- High Image Rejection: -52dBc at 900MHz
- 16-Lead 4mm × 4mm QFN Package

APPLICATIONS

- Infrastructure Tx for GSM/Cellular Bands
- Image Reject Up-Converters for Cellular Bands
- Low-Noise Variable Phase-Shifter for 700MHz to 1050MHz Local Oscillator Signals
- RFID Reader

DESCRIPTION

The LT[®]5568-2 is a direct I/Q modulator designed for high performance wireless applications, including wireless infrastructure. It allows direct modulation of an RF signal using differential baseband I and Q signals. It supports GSM, EDGE, CDMA, CDMA2000 and other systems that operate in the 850MHz to 965MHz band. It may be configured as an image reject upconverting mixer, by applying 90° phase-shifted signals to the I and Q inputs. The I/Q baseband inputs consist of voltage-to-current converters that in turn drive double-balanced mixers. The outputs of these mixers are summed and applied to an on-chip RF transformer, which converts the differential mixer signals to a 50Ω single-ended output. The four balanced I and Q baseband input ports are intended for DC coupling from a source with a common mode voltage level of about 0.5V. The LO path consists of an LO buffer with single-ended input, and precision quadrature generators that produce the LO drive for the mixers. The supply voltage range is 4.5V to 5.25V.

LT, LT, LTC and LTM are registered trademarks of Linear Technology Corporation. All other trademarks are the property of their respective owners.

TYPICAL APPLICATION

850MHz to 965MHz Direct Conversion Transmitter Application

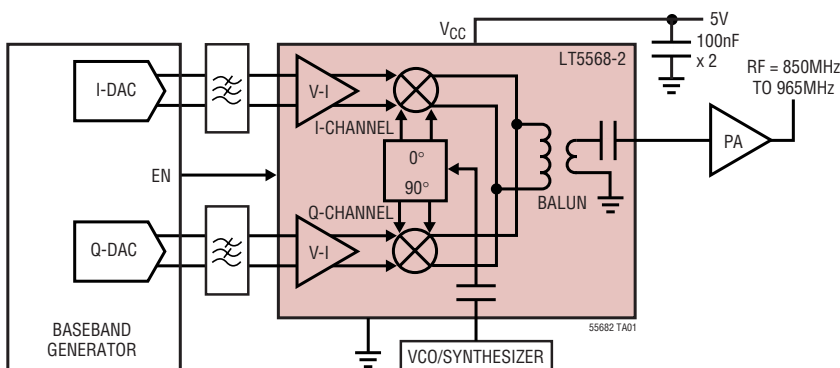

GSM EVM and Noise
vs RF Output Power at 900MHz

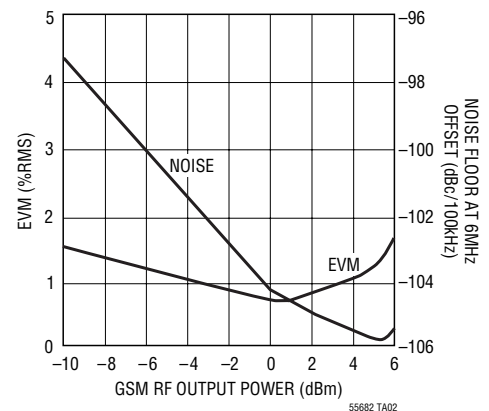

ABSOLUTE MAXIMUM RATINGS

(Note 1)

Supply Voltage	5.5V
Common Mode Level of BBPI, BBMI and BBPQ, BBMQ	2.5V
Operating Ambient Temperature (Note 2)	-40°C to 85°C
Storage Temperature Range.....	-65°C to 125°C
Voltage on Any Pin Not to Exceed.....	-500mV to $V_{CC} + 500mV$

CAUTION: This part is sensitive to ESD. It is very important that proper ESD precautions be observed when handling the LT5568-2.

PIN CONFIGURATION

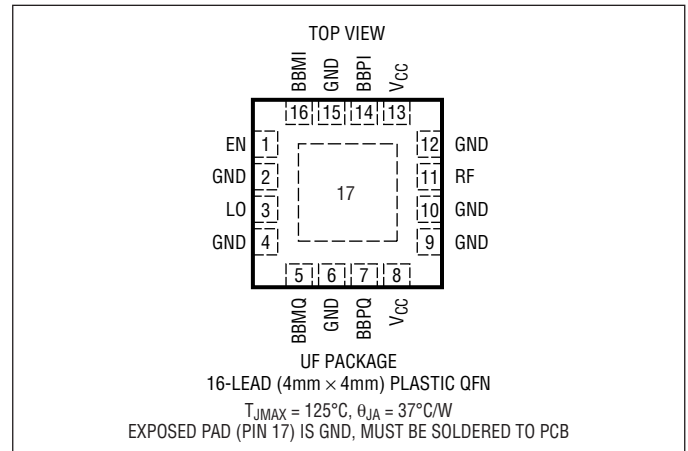

ORDER INFORMATION

LEAD FREE FINISH	TAPE AND REEL	PART MARKING	PACKAGE DESCRIPTION	TEMPERATURE RANGE
LT5568-2EUF#PBF	LT5568-2EUF#TRPBF	55682	16-Lead (4mm x 4mm) Plastic QFN	-40°C to 85°C

Consult LTC Marketing for parts specified with wider operating temperature ranges.

Consult LTC Marketing for information on non-standard lead based finish parts.

For more information on lead free part marking, go to: <http://www.linear.com/leadfree/>

For more information on tape and reel specifications, go to: <http://www.linear.com/tapeandree/>

ELECTRICAL CHARACTERISTICS

$V_{CC} = 5V$, $EN = High$, $T_A = 25^\circ C$, $f_{LO} = 900MHz$, $f_{RF} = 902MHz$, $P_{LO} = 0dBm$.
BBPI, BBMI, BBPQ, BBMQ inputs $0.54V_{DC}$, Baseband Input Frequency = 2MHz, I&Q 90° shifted (upper side-band selection).
 $P_{RF, OUT} = -10dBm$, unless otherwise noted. (Note 3)

SYMBOL	PARAMETER	CONDITIONS	MIN	TYP	MAX	UNITS
RF Output (RF)						
f_{RF}	RF Frequency Range	-3dB Bandwidth		0.6 to 1.1		GHz
	RF Frequency Range	-1dB Bandwidth		0.7 to 1		GHz
$S_{22, ON}$	RF Output Return Loss	$EN = High$ (Note 6)		-16		dB
$S_{22, OFF}$	RF Output Return Loss	$EN = Low$ (Note 6)		-18		dB
NFloor	RF Output Noise Floor	No Input Signal (Note 8)		-159.4		dBm/Hz
		$P_{OUT} = 4dBm$ (Note 9)		-153		dBm/Hz
		$P_{OUT} = 4dBm$ (Note 10)		-152.6		dBm/Hz
G_P	Conversion Power Gain	$P_{OUT}/P_{IN, I\&Q}$	-9	-6.8	-3	dB
G_V	Conversion Voltage Gain	$20 \cdot \log(V_{OUT, 50\Omega}/V_{IN, DIFF, I\ or\ Q})$		-6.8		dB
P_{OUT}	Absolute Output Power	1V _{P-P} DIFF CW Signal, I and Q		-2.8		dBm
$G_{3LO\ vs\ LO}$	3 • LO Conversion Gain Difference	(Note 17)		-23		dB
OP1dB	Output 1dB Compression	(Note 7)		8.6		dBm
OIP2	Output 2nd Order Intercept	(Notes 13, 14)		59		dBm
OIP3	Output 3rd Order Intercept	(Notes 13, 15)		22.9		dBm

ELECTRICAL CHARACTERISTICS $V_{CC} = 5V$, EN = High, $T_A = 25^\circ C$, $f_{LO} = 900MHz$, $f_{RF} = 902MHz$, $P_{LO} = 0dBm$.
 BBPI, BBMI, BBPQ, BBMQ inputs $0.54V_{DC}$, Baseband Input Frequency = 2MHz, I&Q 90° shifted (upper side-band selection).
 $P_{RF, OUT} = -10dBm$, unless otherwise noted. (Note 3)

SYMBOL	PARAMETER	CONDITIONS	MIN	TYP	MAX	UNITS
IR	Image Rejection	$f_{BB} = 100kHz$ (Note 16)		-52		dBc
LOFT	Carrier Leakage (LO Feedthrough)	EN = High, $P_{LO} = 0dBm$ (Note 16) EN = Low, $P_{LO} = 0dBm$ (Note 16)		-43 -65		dBm dBm

LO Input (LO)

f_{LO}	LO Frequency Range			0.6 to 1.1		GHz
P_{LO}	LO Input Power		-10	0	5	dBm
$S_{11, ON}$	LO Input Return Loss	EN = High (Note 6)		-15		dB
$S_{11, OFF}$	LO Input Return Loss	EN = Low (Note 6)		-2.5		dB
NF_{LO}	LO Input Referred Noise Figure	(Note 5) at 900MHz		14.7		dB
G_{LO}	LO to RF Small Signal Gain	(Note 5) at 900MHz		14.7		dB
$IIP3_{LO}$	LO Input 3rd Order Intercept	(Note 5) at 900MHz		-3		dBm

Baseband Inputs (BBPI, BBMI, BBPQ, BBMQ)

BW_{BB}	Baseband Bandwidth	-3dB Bandwidth		380		MHz
V_{CMBB}	DC Common Mode Voltage	(Note 4)		0.54		V
$R_{IN, SE}$	Single-Ended Input Resistance	(Note 4)		47		Ω
P_{LO2BB}	Carrier Feedthrough on BB	$P_{OUT} = 0$ (Note 4)		-38		dBm
IP1dB	Input 1dB Compression Point	Differential Peak-to-Peak (Notes 7, 18)		4.3		$V_{P-P, DIFF}$

Power Supply (V_{CC})

V_{CC}	Supply Voltage		4.5	5	5.25	V
$I_{CC, ON}$	Supply Current	EN = High	80	110	145	mA
$I_{CC, OFF}$	Supply Current, Sleep Mode	EN = 0V			100	μA
t_{ON}	Turn-On Time	EN = Low to High (Note 11)		0.3		μs
t_{OFF}	Turn-Off Time	EN = High to Low (Note 12)		1.4		μs

Enable (EN), Low = Off, High = On

Enable	Input High Voltage Input High Current	EN = High EN = 5V	1.0	245		V μA
Sleep	Input Low Voltage Input Low Current	EN = Low EN = 0V		0.01	0.5	V μA

Note 1: Stresses beyond those listed under Absolute Maximum Ratings may cause permanent damage to the device. Exposure to any Absolute Maximum Rating condition for extended periods may affect device reliability and lifetime.

Note 2: Specifications over the $-40^\circ C$ to $85^\circ C$ temperature range are assured by design, characterization and correlation with statistical process controls.

Note 3: Tests are performed as shown in the configuration of Figure 7.

Note 4: On each of the four baseband inputs BBPI, BBMI, BBPQ and BBMQ.

Note 5: $V(BBPI) - V(BBMI) = 1V_{DC}$, $V(BBPQ) - V(BBMQ) = 1V_{DC}$.

Note 6: Maximum value within 850MHz to 965MHz.

Note 7: An external coupling capacitor is used in the RF output line.

Note 8: At 20MHz offset from the LO signal frequency.

Note 9: At 20MHz offset from the CW signal frequency.

Note 10: At 5MHz offset from the CW signal frequency.

Note 11: RF power is within 10% of final value.

Note 12: RF power is at least 30dB lower than in the ON state.

Note 13: Baseband is driven by 2MHz and 2.1MHz tones. Drive level is set in such a way that the two resulting RF tones are $-10dBm$ each.

Note 14: IM2 measured at LO frequency + 4.1MHz.

Note 15: IM3 measured at LO frequency + 1.9MHz and LO frequency + 2.2MHz.

Note 16: Amplitude average of the characterization data set without image or LO feedthrough nulling (unadjusted).

Note 17: The difference in conversion gain between the spurious signal at $f = 3 \cdot LO - BB$ versus the conversion gain at the desired signal at $f = LO + BB$ for $BB = 2MHz$ and $LO = 900MHz$.

Note 18: The input voltage corresponding to the output P1dB.

TYPICAL PERFORMANCE CHARACTERISTICS $V_{CC} = 5V$, $EN = High$, $T_A = 25^\circ C$, $f_{LO} = 900MHz$, $P_{LO} = 0dBm$. BBPI, BBMI, BBPQ, BBMQ inputs $0.54V_{DC}$, Baseband Input Frequency $f_{BB} = 2MHz$, I&Q 90° shifted. $f_{RF} = f_{BB} + f_{LO}$ (upper sideband selection). $P_{RF, OUT} = -10dBm$ ($-10dBm/$ tone for 2-tone measurements), unless otherwise noted. (Note 3)

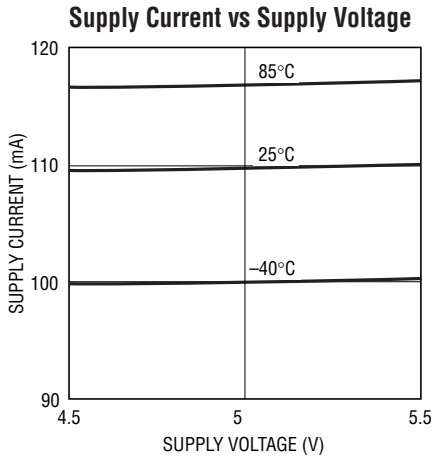

55682 G01

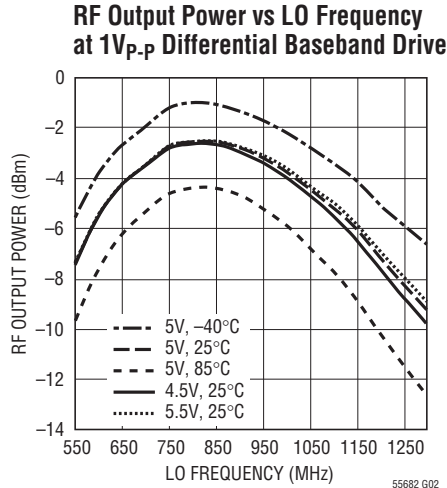

55682 G02

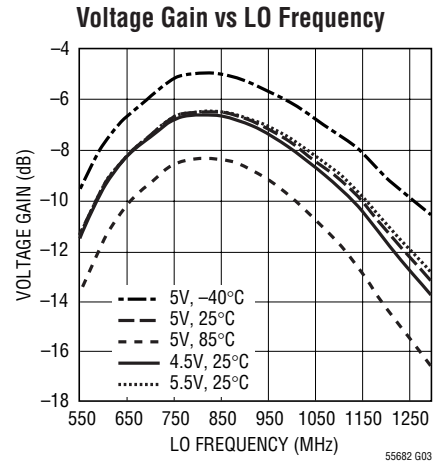

55682 G03

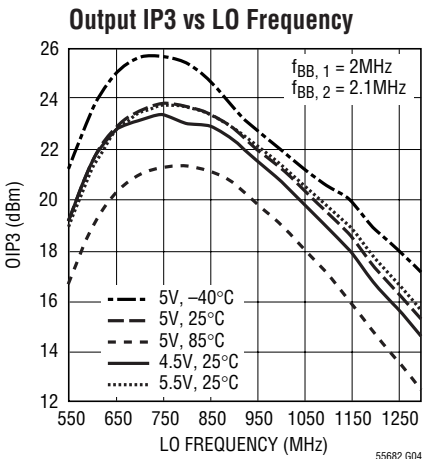

55682 G04

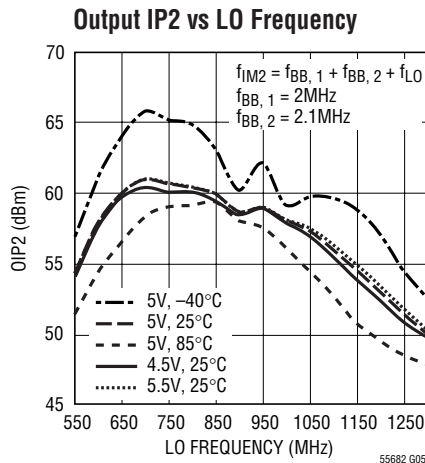

55682 G05

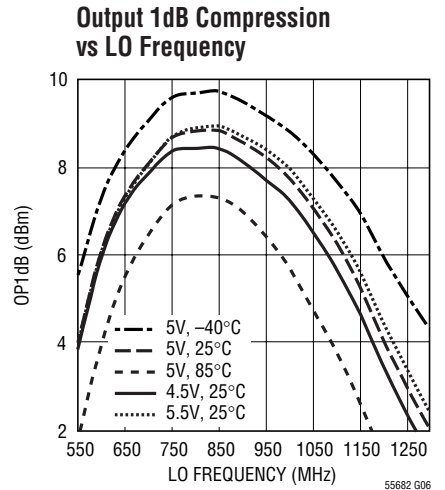

55682 G06

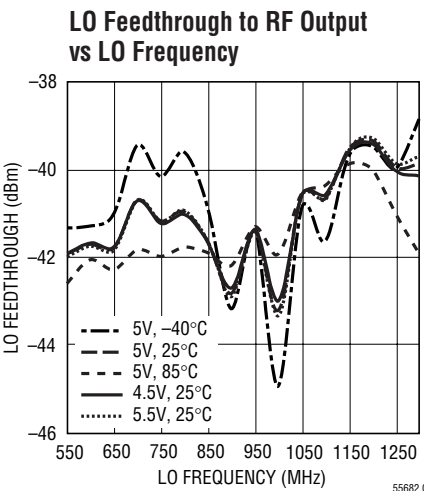

55682 G07

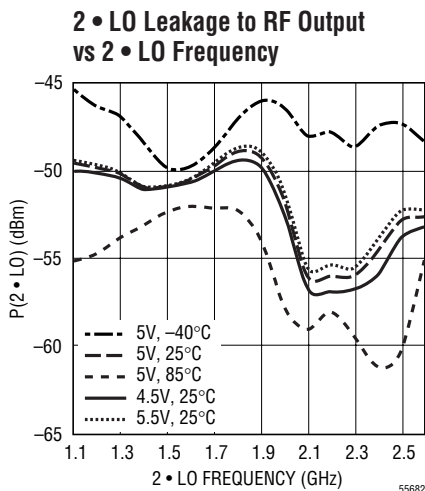

55682 G08

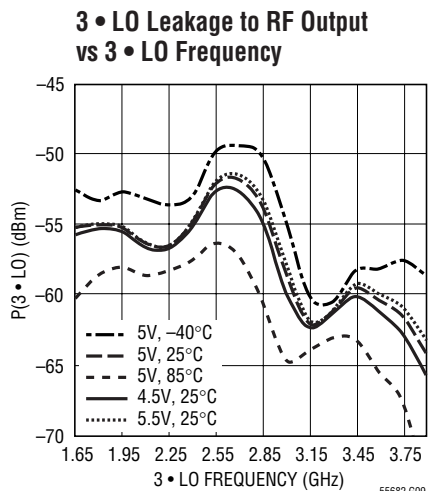

55682 G09

55682 F1

TYPICAL PERFORMANCE CHARACTERISTICS $V_{CC} = 5V$, $EN = High$, $T_A = 25^{\circ}C$, $f_{LO} = 900MHz$, $P_{LO} = 0dBm$. BBPI, BBMI, BBPQ, BBMQ inputs $0.54V_{DC}$, Baseband Input Frequency $f_{BB} = 2MHz$, I&Q 90° shifted. $f_{RF} = f_{BB} + f_{LO}$ (upper sideband selection). $P_{RF, OUT} = -10dBm$ (-10dBm/tone for 2-tone measurements), unless otherwise noted. (Note 3)

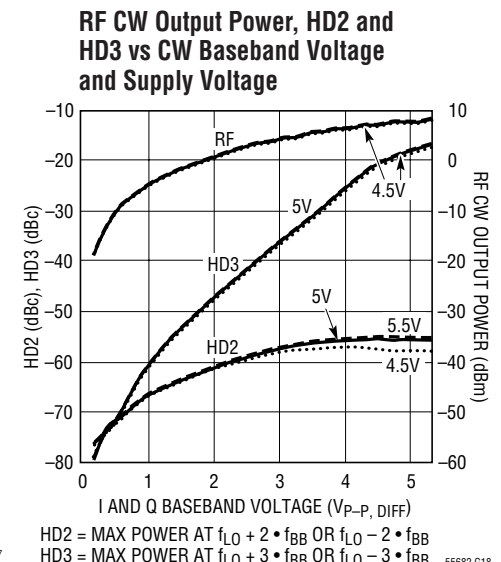
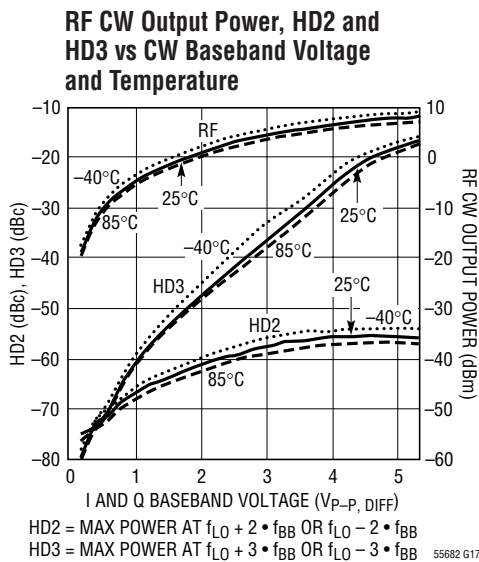
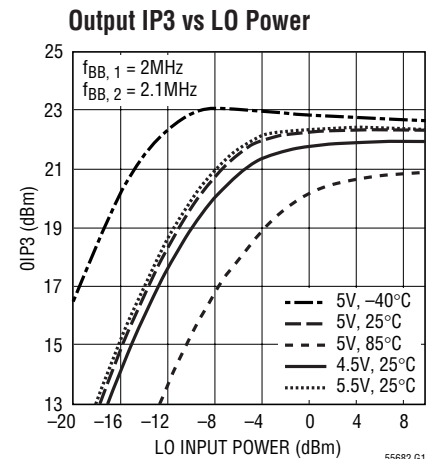
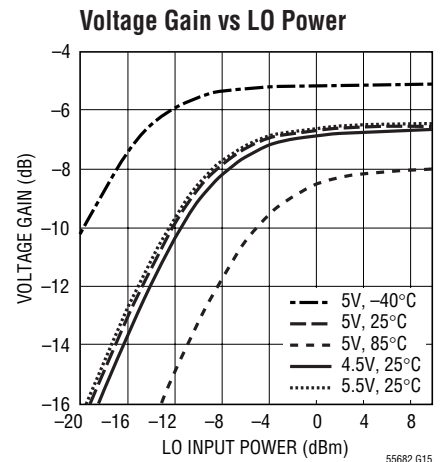
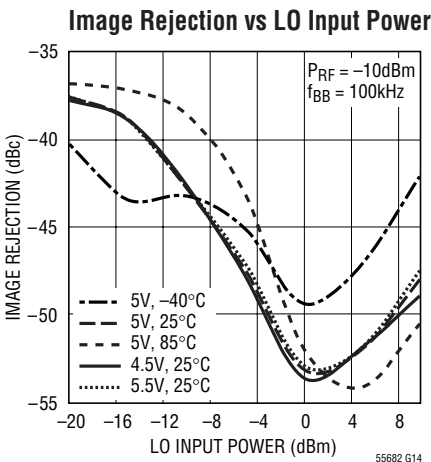
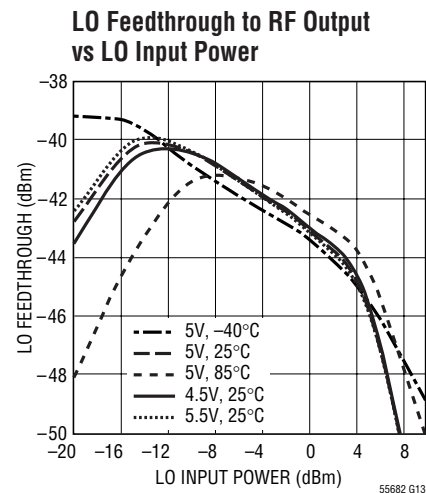
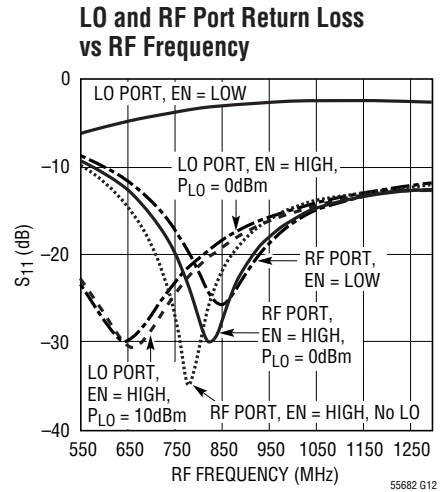
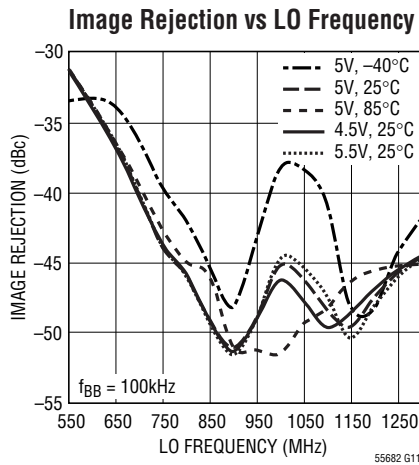
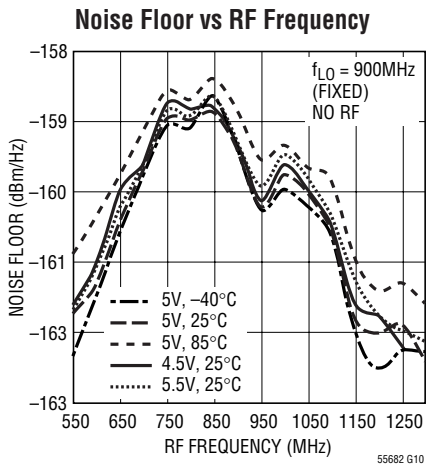

TYPICAL PERFORMANCE CHARACTERISTICS $V_{CC} = 5V$, EN = High, $T_A = 25^\circ C$, $f_{LO} = 900MHz$, $P_{LO} = 0dBm$. BBPI, BBMI, BBPQ, BBMQ inputs $0.54V_{DC}$, Baseband Input Frequency $f_{BB} = 2MHz$, I&Q 90° shifted. $f_{RF} = f_{BB} + f_{LO}$ (upper sideband selection). $P_{RF, OUT} = -10dBm$ (-10dBm/tone for 2-tone measurements), unless otherwise noted. (Note 3)

LO Feedthrough to RF Output vs CW Baseband Voltage

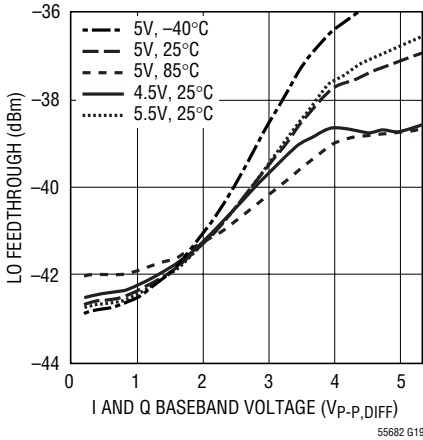
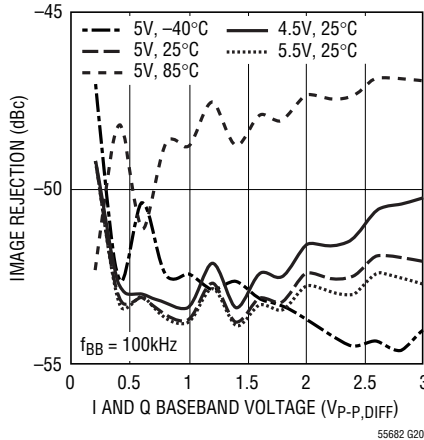
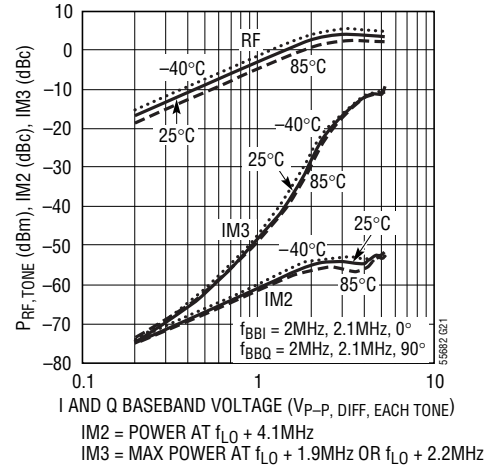

Image Rejection vs CW Baseband Voltage



RF Two-Tone Power (Each Tone), IM2 and IM3 vs Baseband Voltage and Temperature



RF Two-Tone Power (Each Tone), IM2 and IM3 vs Baseband Voltage and Supply Voltage

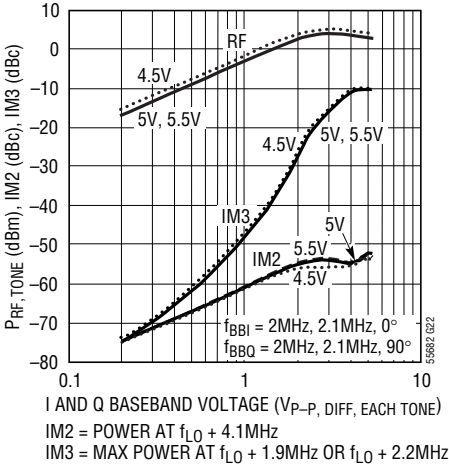

Gain Distribution

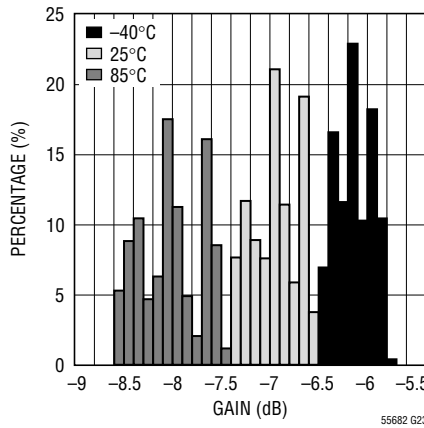

Noise Floor Distribution

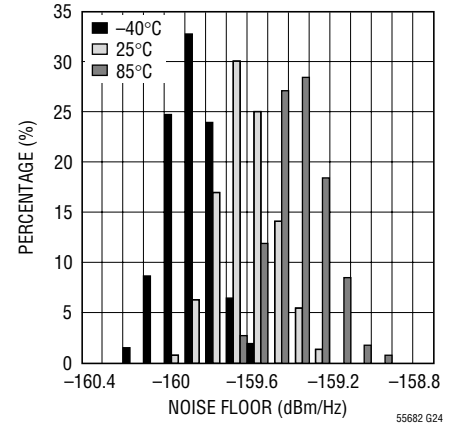

LO Leakage Distribution

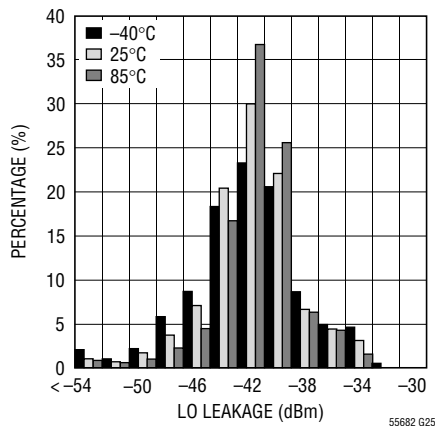
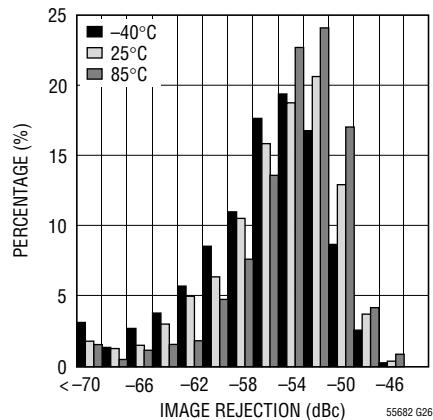

Image Rejection Distribution



PIN FUNCTIONS

EN (Pin 1): Enable Input. When the enable pin voltage is higher than 1V, the IC is turned on. When the input voltage is less than 0.5V, the IC is turned off.

GND (Pins 2, 4, 6, 9, 10, 12, 15): Ground. Pins 6, 9, 15 and 17 (exposed pad) are connected to each other internally. Pins 2 and 4 are connected to each other internally and function as the ground return for the LO signal. Pins 10 and 12 are connected to each other internally and function as the ground return for the on-chip RF balun. For best RF performance, pins 2, 4, 6, 9, 10, 12, 15 and the Exposed Pad 17 should be connected to the printed circuit board ground plane.

LO (Pin 3): LO Input. The LO input is an AC-coupled single-ended input with approximately 50Ω input impedance at RF frequencies. Externally applied DC voltage should be within the range $-0.5V$ to $V_{CC} + 0.5V$ in order to avoid turning on ESD protection diodes.

BBPQ, BBMQ (Pins 7, 5): Baseband Inputs for the Q-channel, each 50Ω input impedance. Internally biased at about 0.54V. Applied voltage must stay below 2.5V.

V_{CC} (Pins 8, 13): Power Supply. Pins 8 and 13 are connected to each other internally. It is recommended to use $0.1\mu F$ capacitors for decoupling to ground on each of these pins.

RF (Pin 11): RF Output. The RF output is an AC-coupled single-ended output with approximately 50Ω output impedance at RF frequencies. Externally applied DC voltage should be within the range $-0.5V$ to $V_{CC} + 0.5V$ in order to avoid turning on ESD protection diodes.

BBPI, BBMI (Pins 14, 16): Baseband Inputs for the I-channel, each with 50Ω input impedance. Internally biased at about 0.54V. Applied voltage must stay below 2.5V.

Exposed Pad (Pin 17): Ground. This pin must be soldered to the printed circuit board ground plane.

BLOCK DIAGRAM

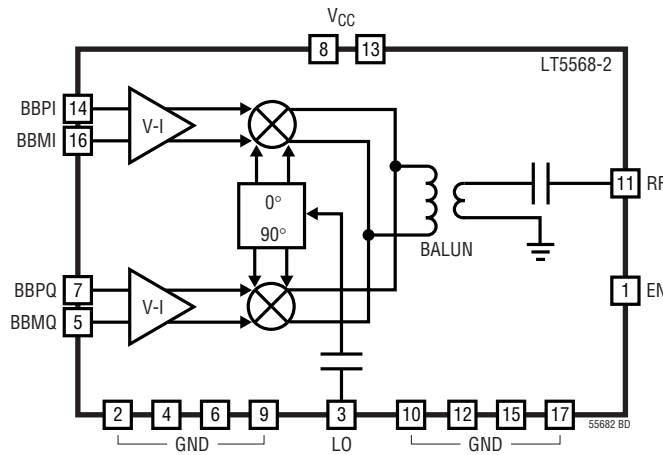

APPLICATIONS INFORMATION

The LT5568-2 consists of I and Q input differential voltage-to-current converters, I and Q up-conversion mixers, an RF output balun, an LO quadrature phase generator and LO buffers.

External I and Q baseband signals are applied to the differential baseband input pins, BBPI, BBMI, and BBPQ, BBMQ. These voltage signals are converted to currents and translated to RF frequency by means of double-balanced up-converting mixers. The mixer outputs are combined in an RF output balun, which also transforms the output impedance to 50Ω. The center frequency of the resulting RF signal is equal to the LO signal frequency. The LO input drives a phase shifter which splits the LO signal into in-phase and quadrature LO signals. These LO signals are then applied to on-chip buffers which drive the up-conversion mixers. Both the LO input and RF output are single-ended, 50Ω-matched and AC coupled.

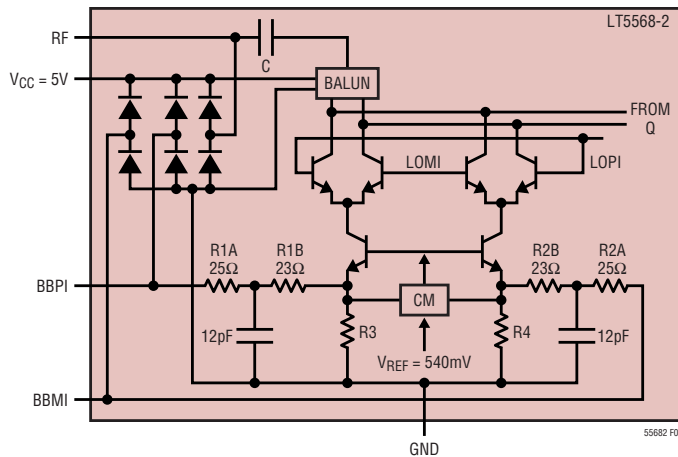

Figure 1. Simplified Circuit Schematic of the LT5568-2 (Only I-Half is Drawn)

Baseband Interface

The baseband inputs (BBPI, BBMI), (BBPQ, BBMQ) present a differential input impedance of about 100Ω. At each of the four baseband inputs, a first-order lowpass filter using 25Ω

APPLICATIONS INFORMATION

and 12pF to ground is incorporated (see Figure 1), which limits the baseband bandwidth to approximately 330MHz (−1dB point). The common mode voltage is about 0.54V and is approximately constant over temperature.

It is important that the applied common mode voltage level of the I and Q inputs is about 0.54V in order to properly bias the LT5568-2. Some I/Q test generators allow setting the common mode voltage independently. In this case, the common mode voltage of those generators must be set to 0.27V to match the LT5568-2 internal bias, because for DC signals, there is no −6dB source-load voltage division (see Figure 2).

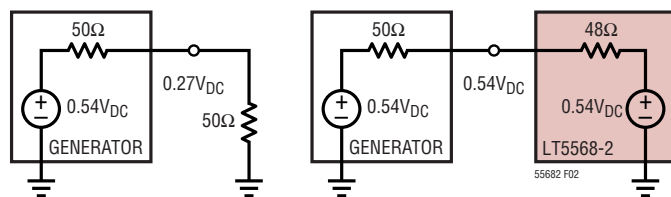

Figure 2. DC Voltage Levels for a Generator Programmed at 0.27V_{DC} for a 50Ω Load and the LT5568-2 as a Load

The baseband inputs should be driven differentially; otherwise, the even-order distortion products will degrade the overall linearity severely. Typically, a DAC will be the signal source for the LT5568-2. Reconstruction filters should be placed between the DAC output and the LT5568-2's baseband inputs. In Figure 3, a typical baseband interface schematic for GSM is drawn. It shows a ground referenced DAC output interface followed by a 3rd order active OpAmp RC lowpass filter with a 400kHz cutoff frequency (−3dB). The DAC in this example sources a current from 0mA to 20mA, with a voltage compliance range of at least 0V to 1V. This interface is DC coupled, which allows adjustment of the DAC's differential output current to minimize the LO feedthrough. The voltage swing at the LT5568-2 baseband inputs is about 2V_{P-P,DIFF}, which results in a 1.2dBm GSM RF output power at 900MHz with noise floor of −154.3dBm/Hz at 6MHz offset (= −104.3dBm/100kHz). The RMS EVM is about 0.6%. The LT1819, which houses two LT1818s, can be used instead of U2 and U3. The total current in the positive supply is about 157mA and the current in the negative supply is about 40mA.

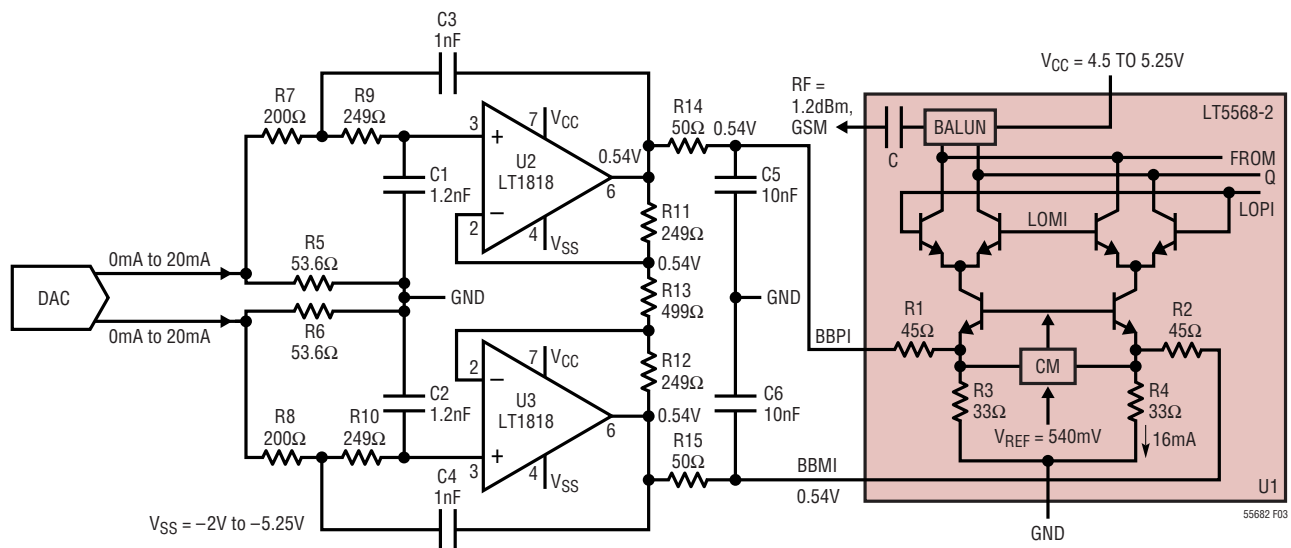

Figure 3. LT5568-2 GSM Baseband Interface with 3rd Order Lowpass Filter and Ground Referenced DAC (Only I-Channel is Shown)

APPLICATIONS INFORMATION

LO Section

The internal LO input amplifier performs single-ended to differential conversion of the LO input signal. Figure 4 shows the equivalent circuit schematic of the LO input.

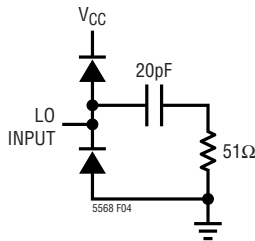

Figure 4. Equivalent Circuit Schematic of the LO Input

The internal, differential LO signal is then split into in-phase and quadrature (90° phase shifted) signals that drive LO buffer sections. These buffers drive the double balanced I and Q mixers. The phase relationship between the LO input and the internal in-phase LO and quadrature LO signals is fixed, and is independent of start-up conditions. The internal phase shifters are designed to deliver accurate quadrature signals. For LO frequencies significantly below 650MHz or above 1.25GHz, however, the quadrature accuracy will diminish, causing the image rejection to degrade. The LO pin input impedance is about 50Ω, and the recommended LO input power is 0dBm. For lower LO input power, the gain, OIP2, OIP3 and noise floor at $P_{RF} = 4\text{dBm}$ will degrade, especially for P_{LO} below -2dBm and at $T_A = 85^\circ\text{C}$. For high LO input power (e.g., $+5\text{dBm}$), the image rejection will degrade with no improvement in linearity or gain. Harmonics present on the LO signal can degrade the image rejection because they can introduce a small excess phase shift in the internal phase splitter. For the second (at 1.8GHz) and third harmonics (at 2.7GHz) at -20dBc , the resulting signal at the image frequency is about -61dBc or lower, corresponding to an excess phase shift of much less than 1 degree. For the second and third LO harmonics at -10dBc , the introduced signal at the image frequency is about -51dBc . Higher harmonics than the third will have less impact. The LO return loss typically will be better than 11dB over the 700MHz to 1.05GHz range. Table 1 shows the LO port input impedance vs frequency.

Table 1. LO Port Input Impedance vs Frequency for EN = High and $P_{LO} = 0\text{dBm}$

Frequency MHz	Input Impedance Ω	S_{11}	
		Mag	Angle
500	$47.5 + j12.1$	0.126	95.0
600	$59.4 + j8.4$	0.115	37.8
700	$66.2 - j1.14$	0.140	-3.41
800	$67.2 - j13.4$	0.185	-31.7
900	$61.1 - j23.9$	0.232	-53.2
1000	$53.3 - j26.8$	0.252	-68.7
1100	$48.2 - j26.1$	0.258	-79.4
1200	$42.0 - j27.4$	0.297	-90.0

If the part is in shutdown mode, the input impedance of the LO port will be different. The LO input impedance for EN = Low is given in Table 2.

Table 2. LO Port Input Impedance vs Frequency for EN = Low and $P_{LO} = 0\text{dBm}$

Frequency MHz	Input Impedance Ω	S_{11}	
		Mag	Angle
500	$33.6 + j41.3$	0.477	85.4
600	$59.8 + j69.1$	0.539	49.8
700	$140 + j89.8$	0.606	19.6
800	$225 - j62.6$	0.659	-6.8
900	$92.9 - j128$	0.704	-29.6
1000	$39.8 - j95.9$	0.735	-45.5
1100	$22.8 - j72.7$	0.755	-65.6
1200	$16.0 - j57.3$	0.763	-79.7

RF Section

After up-conversion, the RF outputs of the I and Q mixers are combined. An on-chip balun performs internal differential to single-ended output conversion, while transforming the output signal impedance to 50Ω. Table 3 shows the RF port output impedance vs frequency.

Table 3. RF Port Output Impedance vs Frequency for EN = High and $P_{LO} = 0\text{dBm}$

Frequency MHz	Input Impedance Ω	S_{22}	
		Mag	Angle
500	$22.0 + j5.7$	0.395	164.2
600	$28.2 + j12.5$	0.317	141.3
700	$38.8 + j14.8$	0.206	117.5
800	$49.4 + j7.2$	0.072	90.6
900	$49.3 - j5.1$	0.051	-94.7
1000	$42.5 - j11.1$	0.143	-117.0
1100	$36.7 - j11.7$	0.202	-130.7
1200	$33.0 - j10.3$	0.238	-141.6

55682f

APPLICATIONS INFORMATION

The RF output S_{22} with no LO power applied is given in Table 4.

Table 4. RF Port Output Impedance vs Frequency for EN = High and No LO Power Applied

Frequency MHz	Input Impedance Ω	S_{22}	
		Mag	Angle
500	22.7 + j5.6	0.381	164.0
600	29.7 + j11.6	0.290	142.0
700	40.5 + j11.6	0.164	121.9
800	47.3 + j2.2	0.037	139.6
900	44.1 - j6.7	0.094	-126.9
1000	38.2 - j9.8	0.171	-133.9
1100	34.0 - j9.4	0.218	-143.1
1200	31.5 - j7.8	0.245	-151.6

For EN = Low the S_{22} is given in Table 5.

Table 5. RF Port Output Impedance vs Frequency for EN = Low

Frequency MHz	Input Impedance Ω	S_{22}	
		Mag	Angle
500	21.2 + j5.4	0.409	164.9
600	26.6 + j12.5	0.340	142.5
700	36.6 + j16.6	0.241	118.1
800	49.2 + j11.6	0.116	87.4
900	52.9 - j2.0	0.034	-33.1
1000	46.4 - j11.2	0.121	-101.1
1100	39.3 - j13.2	0.188	-120.6
1200	34.4 - j12.1	0.231	-133.8

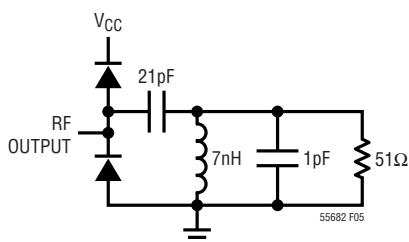

Figure 5. Equivalent Circuit Schematic of the RF Output

Note that an ESD diode is connected internally from the RF output to ground (see Figure 5). For strong output RF signal levels (higher than 3dBm), this ESD diode can degrade the linearity performance if the 50Ω termination impedance is connected directly to ground. To prevent this, a coupling capacitor can be inserted in the RF output line. This is strongly recommended during a 1dB compression measurement.

Enable Interface

Figure 6 shows a simplified schematic of the EN pin interface. The voltage necessary to turn on the LT5568-2 is 1V. To disable (shut down) the chip, the enable voltage must be below 0.5V. If the EN pin is not connected, the chip is disabled. This EN = Low condition is assured by the 75k on-chip pull-down resistor. It is important that the voltage at the EN pin does not exceed V_{CC} by more than 0.5V. If this should occur, the supply current could be sourced through the EN pin ESD protection diodes, which are not designed to carry the full supply current, and damage may result.

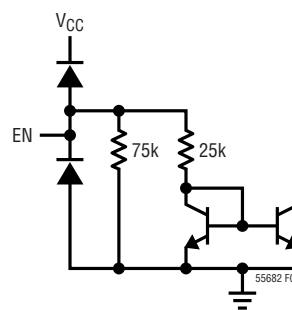

Figure 6. EN Pin Interface

APPLICATIONS INFORMATION

Evaluation Board

Figure 7 shows the evaluation board schematic. A good ground connection is required for the exposed pad. If this is not done properly, the RF performance will degrade. Additionally, the exposed pad provides heat sinking for the part and minimizes the possibility of the chip overheating.

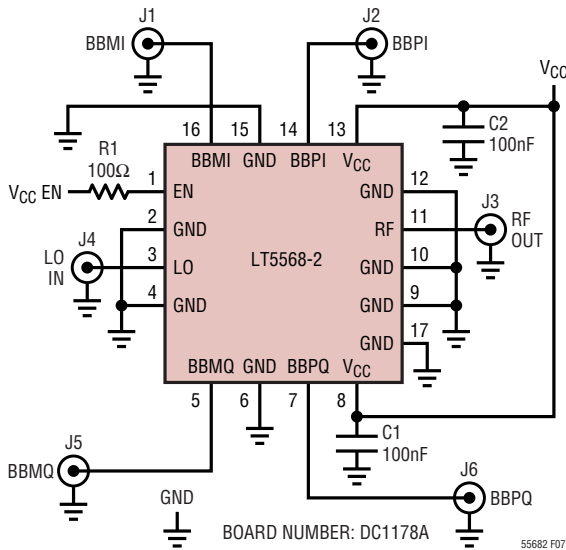

Figure 7. Evaluation Circuit Schematic

R1 (optional) limits the EN pin current in the event that the EN pin is pulled high while the V_{CC} inputs are low. In Figures 8 and 9 the silk screens and the PCB board layout are shown.

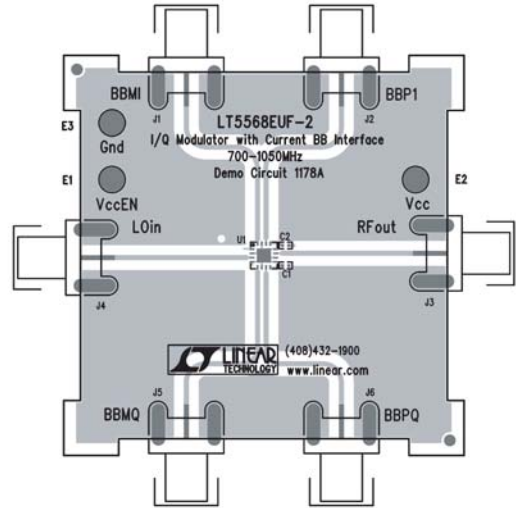

Figure 8. Component Side of Evaluation Board

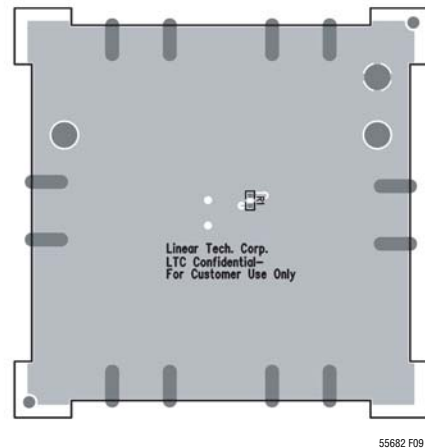

Figure 9. Bottom Side of Evaluation Board

APPLICATIONS INFORMATION

Application Measurements

The LT5568-2 is recommended for base-station applications using various modulation formats. Figure 10 shows a typical application. Figure 11 shows the ACPR performance for CDMA2000 using 1- and 3-carrier modulation. Figures 12 and 13 illustrate the 1- and 3-carrier CDMA2000 RF spectrum. To calculate ACPR, a correction is made for the spectrum analyzer noise floor. If the output power is high, the ACPR will be limited by the linearity performance of the part. If the output power is low, the ACPR will be limited by the noise performance of the part. In the middle, an optimum ACPR is observed.

Because of the LT5568-2's very high dynamic range, the test equipment can limit the accuracy of the ACPR measurement. See Application Note 99. Consult the factory for advice on the ACPR measurement, if needed.

The ACPR performance is sensitive to the amplitude match of the BBPI and BBMI (or BBPQ and BBMQ) inputs. This is because a difference in AC current amplitude will give rise to a difference in amplitude between the even-order harmonic products generated in the internal V-I converter. As a result, they will not cancel out entirely. Therefore, it is important to keep the currents in those pins exactly

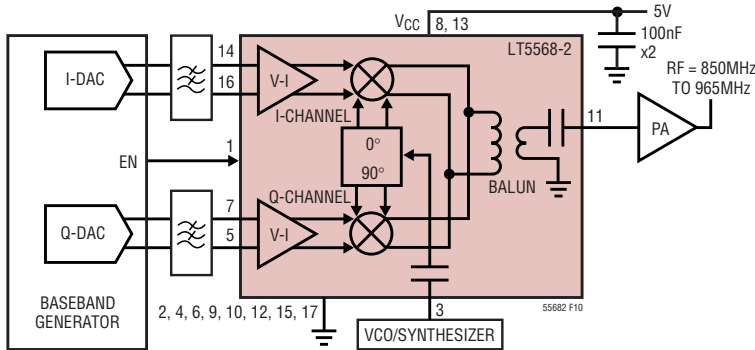

Figure 10. 850MHz to 965MHz Direct Conversion Transmitter Application

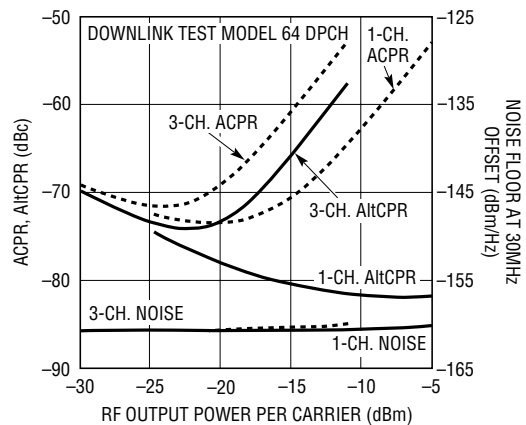

Figure 11. ACPR, AltCPR and Noise CDMA2000 Modulation

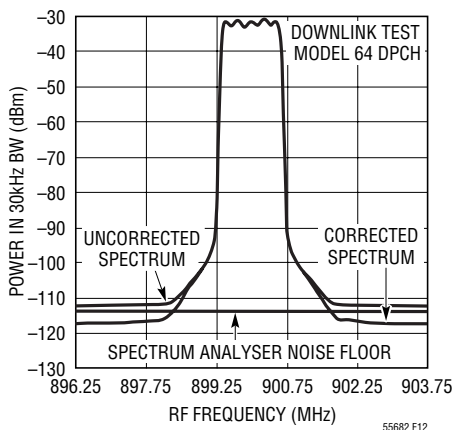

Figure 12. 1-Carrier CDMA2000 Spectrum

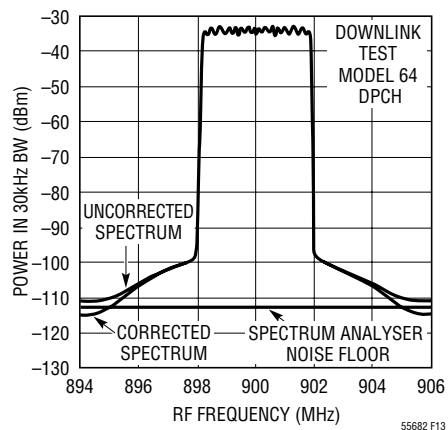

Figure 13. 3-Carrier CDMA2000 Spectrum

APPLICATIONS INFORMATION

the same (but of opposite sign). The current will enter the LT5568-2's common-base stage, and will flow to the mixer upper switches. This can be seen in Figure 1 where the internal circuit of the LT5568-2 is drawn.

After calibration when the temperature changes, the LO feedthrough and the image rejection performance will

change. This is illustrated in Figure 14. The LO feedthrough and image rejection can also change as a function of the baseband drive level, as is depicted in Figure 15. In Figure 16 the GSM EVM and noise performance vs RF output power is drawn.

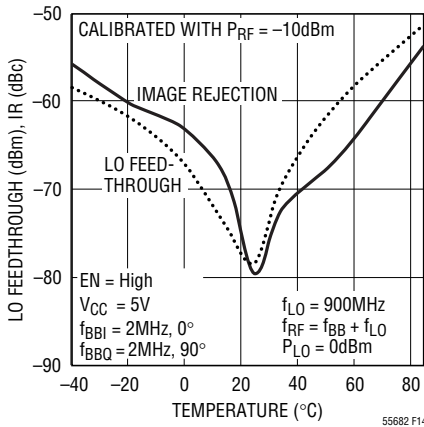

Figure 14. LO Feedthrough and Image Rejection vs Temperature after Calibration at 25°C

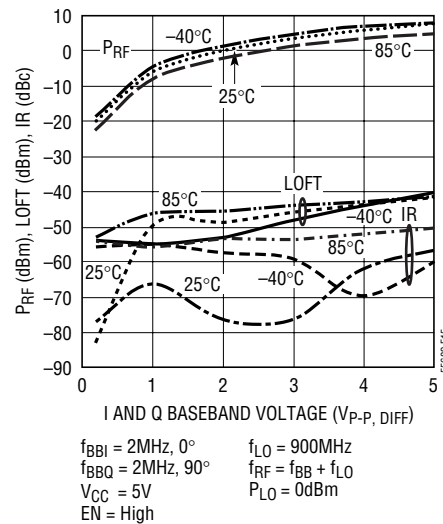

Figure 15. LO Feedthrough and Image Rejection vs Baseband Drive Voltage after Calibration at 25°C

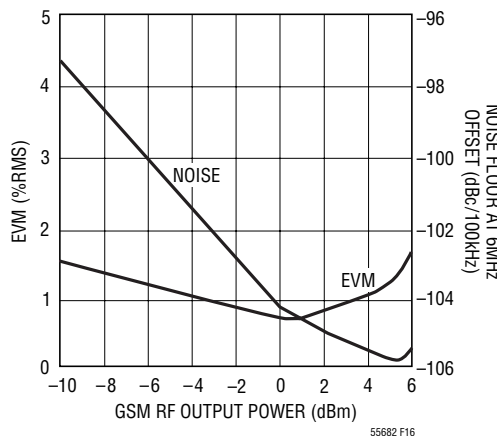
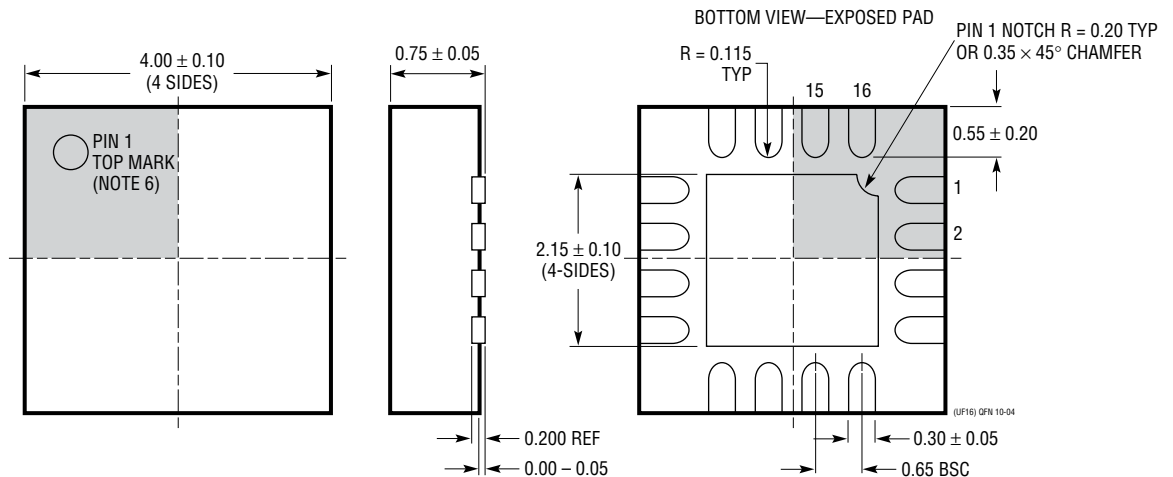
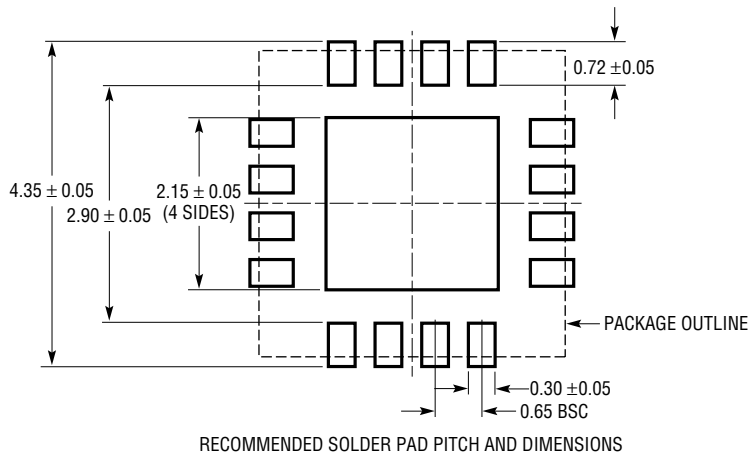

Figure 16. GSM EVM and Noise vs RF Output Power at 900MHz

PACKAGE DESCRIPTION

UF Package 16-Lead Plastic QFN (4mm × 4mm) (Reference LTC DWG # 05-08-1692)



- NOTE:
1. DRAWING CONFORMS TO JEDEC PACKAGE OUTLINE MO-220 VARIATION (WGFC)
 2. DRAWING NOT TO SCALE
 3. ALL DIMENSIONS ARE IN MILLIMETERS
 4. DIMENSIONS OF EXPOSED PAD ON BOTTOM OF PACKAGE DO NOT INCLUDE MOLD FLASH. MOLD FLASH, IF PRESENT, SHALL NOT EXCEED 0.15mm ON ANY SIDE
 5. EXPOSED PAD SHALL BE SOLDER PLATED
 6. SHADED AREA IS ONLY A REFERENCE FOR PIN 1 LOCATION ON THE TOP AND BOTTOM OF PACKAGE

RELATED PARTS

PART NUMBER	DESCRIPTION	COMMENTS
Infrastructure		
LT5514	Ultralow Distortion, IF Amplifier/ADC Driver with Digitally Controlled Gain	850MHz Bandwidth, 47dBm OIP3 at 100MHz, 10.5dB to 33dB Gain Control Range
LT5515	1.5GHz to 2.5GHz Direct Conversion Quadrature Demodulator	20dBm IIP3, Integrated LO Quadrature Generator
LT5516	0.8GHz to 1.5GHz Direct Conversion Quadrature Demodulator	21.5dBm IIP3, Integrated LO Quadrature Generator
LT5517	40MHz to 900MHz Quadrature Demodulator	21dBm IIP3, Integrated LO Quadrature Generator
LT5518	1.5GHz to 2.4GHz High Linearity Direct Quadrature Modulator	22.8dBm OIP3 at 2GHz, -158.2dBm/Hz Noise Floor, 50Ω Single-Ended LO and RF Ports, 4-Ch W-CDMA ACPR = -64dBc at 2.14GHz
LT5519	0.7GHz to 1.4GHz High Linearity Upconverting Mixer	17.1dBm IIP3 at 1GHz, Integrated RF Output Transformer with 50Ω Matching, Single-Ended LO and RF Ports Operation
LT5520	1.3GHz to 2.3GHz High Linearity Upconverting Mixer	15.9dBm IIP3 at 1.9GHz, Integrated RF Output Transformer with 50Ω Matching, Single-Ended LO and RF Ports Operation
LT5521	10MHz to 3700MHz High Linearity Upconverting Mixer	24.2dBm IIP3 at 1.95GHz, NF = 12.5dB, 3.15V to 5.25V Supply, Single-Ended LO Port Operation
LT5522	600MHz to 2.7GHz High Signal Level Downconverting Mixer	4.5V to 5.25V Supply, 25dBm IIP3 at 900MHz, NF = 12.5dB, 50Ω Single-Ended RF and LO Ports
LT5525	High Linearity, Low Power Downconverting Mixer	Single-Ended 50Ω RF and LO Ports, 17.6dBm IIP3 at 1900MHz, I _{CC} = 28mA
LT5526	High Linearity, Low Power Downconverting Mixer	3V to 5.3V Supply, 16.5dBm IIP3, 100kHz to 2GHz RF, NF = 11dB, I _{CC} = 28mA, -65dBm LO-RF Leakage
LT5527	400MHz to 3.7GHz High Signal Level Downconverting Mixer	IIP3 = 23.5dBm and NF = 12.5dB at 1900MHz, 4.5V to 5.25V Supply, I _{CC} = 78mA
LT5528	1.5GHz to 2.4GHz High Linearity Direct Quadrature Modulator	21.8dBm OIP3 at 2GHz, -159.3dBm/Hz Noise Floor, 50Ω, 0.5V _{DC} Baseband Interface, 4-Ch W-CDMA ACPR = -66dBc at 2.14GHz
LT5557	400MHz to 3.8GHz, 3.3V, Very High Linearity Downconverting Mixer	IIP3 = 24.7dBm at 1.9GHz, 23.5dBm at 3.5GHz, Conversion Gain = 2.9dB at 1.9GHz, 3.3V at 82mA, -3dB LO Drive
LT5558	600MHz to 1100MHz High Linearity Direct Quadrature Modulator	22.4dBm OIP3 at 900MHz, -158dBm/Hz Noise Floor, 3kΩ, 2.1V _{DC} Baseband Interface, 3-Ch CDMA2000 ACPR = -70.4dBc at 900MHz
LT5560	Ultra-Low Power Active Mixer	10mA Supply Current, 10dBm IIP3, 10dB NF, Usable as Up- or Down-Converter
LT5568	700MHz to 1050MHz High Linearity Direct Quadrature Modulator	22.9dBm OIP3 at 850MHz, -160.3dBm/Hz Noise Floor, 50Ω, 0.5V _{DC} Baseband Interface, 3-Ch CDMA2000 ACPR = -71.4dBc at 850MHz
LT5572	1.5GHz to 2.5GHz High Linearity Direct Quadrature Modulator	21.6dBm OIP3 at 2GHz, -158.6dBm/Hz Noise Floor, High-Ohmic 0.5V _{DC} Baseband Interface, 4-Ch W-CDMA ACPR = -67.7dBc at 2.14GHz
LT5575	800MHz to 2.7GHz High Linearity Direct Conversion Quadrature Demodulator	28dBm IIP3 and 13.2dBm P1dB at 900MHz, 60dBm IIP2 and 12.7dB NF at 1900MHz
RF Power Detectors		
LTC®5505	RF Power Detectors with >40dB Dynamic Range	300MHz to 3GHz, Temperature Compensated, 2.7V to 6V Supply
LTC5507	100kHz to 1000MHz RF Power Detector	100kHz to 1GHz, Temperature Compensated, 2.7V to 6V Supply
LTC5508	300MHz to 7GHz RF Power Detector	44dB Dynamic Range, Temperature Compensated, SC70 Package
LTC5509	300MHz to 3GHz RF Power Detector	36dB Dynamic Range, Low Power Consumption, SC70 Package
LTC5530	300MHz to 7GHz Precision RF Power Detector	Precision V _{OUT} Offset Control, Shutdown, Adjustable Gain
LTC5531	300MHz to 7GHz Precision RF Power Detector	Precision V _{OUT} Offset Control, Shutdown, Adjustable Offset
LTC5532	300MHz to 7GHz Precision RF Power Detector	Precision V _{OUT} Offset Control, Adjustable Gain and Offset
LT5534	50MHz to 3GHz Log RF Power Detector with 60dB Dynamic Range	±1dB Output Variation over Temperature, 38ns Response Time
LTC5536	Precision 600MHz to 7GHz RF Detector with Fast Comparator	25ns Response Time, Comparator Reference Input, Latch Enable Input, -26dBm to +12dBm Input Range
LT5537	Wide Dynamic Range Log RF/IF Detector	Low Frequency to 800MHz, 83dB Dynamic Range, 2.7V to 5.25V Supply